

## 3. STEAM SYSTEM

### Syllabus

**Steam System:** Properties of steam, Assessment of steam distribution losses, Steam leakages, Steam trapping, Condensate and flash steam recovery system, Identifying opportunities for energy savings.

### 3.1 Introduction

Steam has been a popular mode of conveying energy since the industrial revolution. Steam is used for generating power and also used in process industries such as sugar, paper, fertilizer, refineries, petrochemicals, chemical, food, synthetic fibre and textiles. The following characteristics of steam make it so popular and useful to the industry:

- Highest specific heat and latent heat
- Highest heat transfer coefficient
- Easy to control and distribute
- Cheap and inert

### 3.2 Properties of Steam

Water can exist in the form of solid, liquid and gas as ice, water and steam respectively. If heat energy is added to water, its temperature rises until a value is reached at which the water can no longer exist as a liquid. We call this the "saturation" point and with any further addition of energy, some of the water will boil off as steam. This evaporation requires relatively large amounts of energy, and while it is being added, the water and the steam released are both at the same temperature. Equally, if steam is made to release the energy that was added to evaporate it, then the steam will condense and water at same temperature will be formed.

#### Liquid Enthalpy

Liquid enthalpy is the "Enthalpy" (heat energy) in the water when it has been raised to its boiling point to produce steam, and is measured in kCal/kg, its symbol is  $h_f$ . (also known as "Sensible Heat")

#### Enthalpy of Evaporation (Heat Content of Steam)

The Enthalpy of evaporation is the heat energy to be added to the water (when it has been raised to its boiling point) in order to change it into steam. There is no change in temperature, the steam produced is at the same temperature as the water from which it is produced, but the heat energy added to the water changes its state from water into steam at the same temperature.

The heat required to change the temperature of a substance is called its **sensible heat**.

If 1 kg of water in a vessel at 25°C i.e. containing heat value of 25 kCals is heated by adding 75 kCals, the water is brought to boiling point of 100°C.

To change the water to steam an additional 540 kCal would be required. This quantity of heat required to change a chemical from the liquid to the gaseous state is called **latent heat**.

When the steam condenses back into water, it gives up its enthalpy of evaporation, which it had acquired on changing from water to steam. The enthalpy of evaporation is measured in kCal/kg. Its symbol is  $h_{fg}$ . Enthalpy of evaporation is also known as latent heat.

The temperature at which water boils, also called as boiling point or **saturation temperature** increases as the pressure increases.

When water under pressure is heated its saturation temperature rises above 100 °C. From this it is evident that as the steam pressure increases, the usable heat energy in the steam (enthalpy of evaporation), which is given up when the steam condenses, actually decreases. The total heat of dry saturated steam or enthalpy of saturated steam is given by sum of the two enthalpies  $h_f + h_{fg}$  (Refer Table 3.1 and figure 3.1). When the steam contains moisture the total heat of steam will be  $h_g = h_f + \chi h_{fg}$  where  $\chi$  is the dryness fraction.

The temperature of saturated steam is the same as the water from which it is generated, and corresponds to a fixed and known pressure. Superheat is the addition of heat to dry saturated steam without increase in pressure. The temperature of superheated steam, expressed as degrees above saturation corresponding to the pressure, is referred to as the degrees of **superheat**.

### The Steam Phase Diagram

The data provided in the steam tables can also be expressed in a graphical form. Figure 3.1 illustrates the relationship between the enthalpy and the temperature at various different pressures, and is known as a phase diagram.

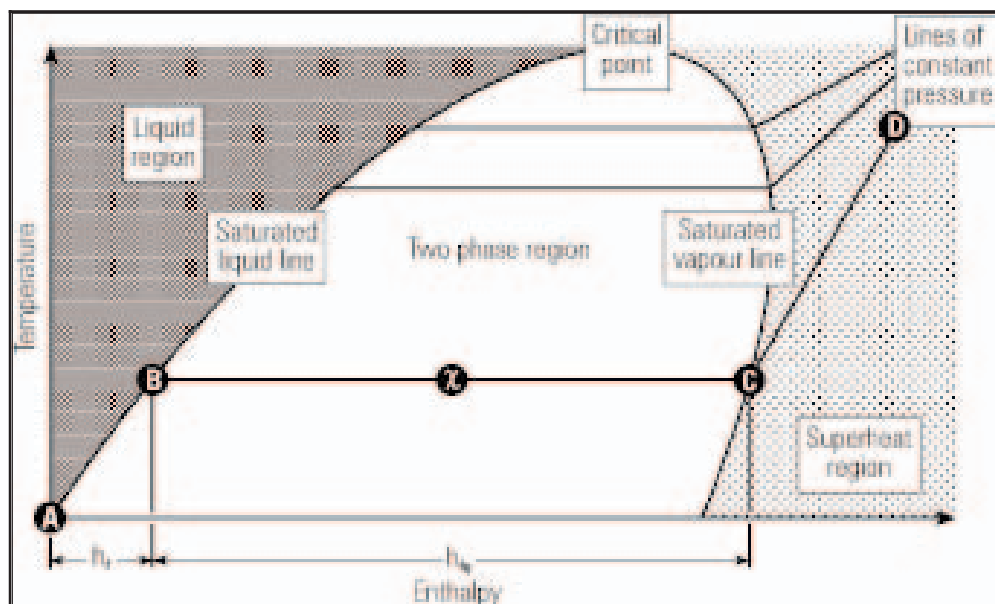

Figure 3.1 Steam Phase Diagram

For a boiler is operating at a pressure of 8 kg/cm<sup>2</sup>, steam saturation temperature is 170 °C, and steam enthalpy or total heat of dry saturated steam is given by:  
 $h_f + h_{fg} = 171.35 + 489.46 = 660.81$  kCal/kg.

If the same steam contains 4% moisture, the total heat of steam is given by:  
 $171.35 + 0.96 \times 489.46 = 641.23$  kCal/kg

As water is heated from 0°C to its saturation temperature, its condition follows the saturated liquid line until it has received all of its liquid enthalpy,  $h_f$ , (A - B).

If further heat continues to be added, it then changes phase to saturated steam and continues to increase in enthalpy while remaining at saturation temperature,  $h_{fg}$ , (B - C).

As the steam/water mixture increases in dryness, its condition moves from the saturated liquid line to the saturated vapour line. Therefore at a point exactly halfway between these two states, the dryness fraction ( $\chi$ ) is 0.5. Similarly, on the saturated vapour line the steam is 100% dry.

Once it has received all of its enthalpy of evaporation, it reaches the saturated vapour line. If it continues to be heated after this point, the temperature of the steam will begin to rise as superheat is imparted (C - D).

The saturated liquid and saturated vapour lines enclose a region in which a steam/water mixture exists - wet steam. In the region to the left of the saturated liquid line only water exists, and in the region to the right of the saturated vapour line only superheated steam exists.

The point at which the saturated liquid and saturated vapour lines meet is known as the critical point. As the pressure increases towards the critical point the enthalpy of evaporation decreases, until it becomes zero at the critical point. This suggests that water changes directly into saturated steam at the critical point.

Above the critical point only gas may exist. The gaseous state is the most diffuse state in which the molecules have an almost unrestricted motion, and the volume increases without limit as the pressure is reduced.

The critical point is the highest temperature at which liquid can exist. Any compression at constant temperature above the critical point will not produce a phase change.

Compression at constant temperature below the critical point however, will result in liquefaction of the vapour as it passes from the superheated region into the wet steam region.

The critical point occurs at 374.15°C and 221.2 bar (a) for steam. Above this pressure the steam is termed supercritical and no well-defined boiling point applies.

**TABLE 3.1 EXTRACT FROM THE STEAM TABLES**

Pressure (kg/cm <sup>2</sup> )	Temperature °C	Enthalpy in kCal/kg			Specific Volume (m <sup>3</sup> /kg)
		Water ( $h_f$ )	Evaporation ( $h_{fg}$ )	Steam ( $h_g$ )	
1	100	100.09	539.06	639.15	1.673
2	120	119.92	526.26	646.18	0.901
3	133	133.42	517.15	650.57	0.616
4	143	143.70	509.96	653.66	0.470
5	151	152.13	503.90	656.03	0.381
6	158	159.33	498.59	657.92	0.321
7	164	165.67	493.82	659.49	0.277
8	170	171.35	489.46	660.81	0.244

### 3.3 Steam Distribution

The steam distribution system is the essential link between the steam generator and the steam user. Whatever the source, an efficient steam distribution system is essential if steam of the right quality and pressure is to be supplied, in the right quantity, to the steam using equipment. Installation and maintenance of the steam system are important issues, and must be considered at the design stage.

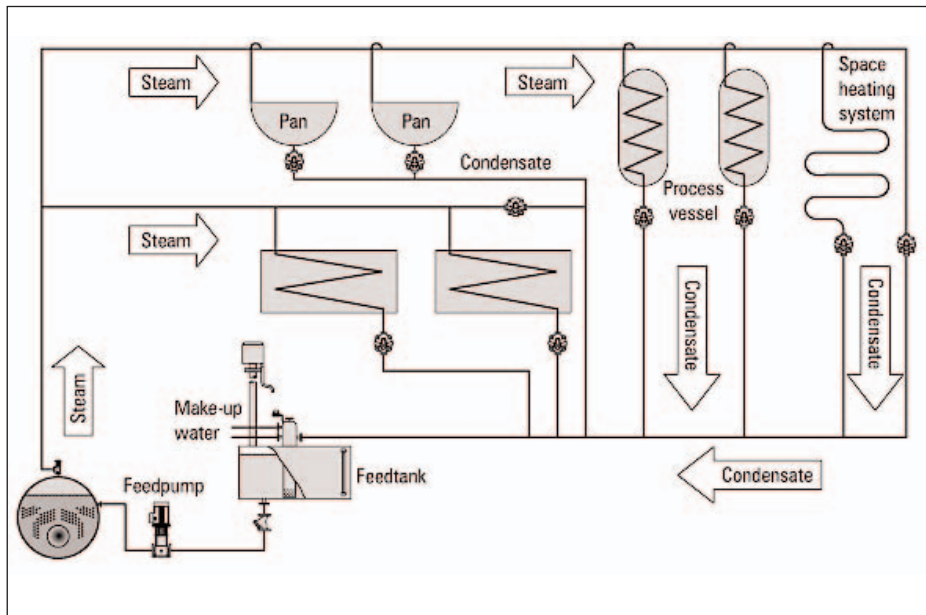

Figure 3.2 Steam Distribution System

As steam condenses in a process, flow is induced in the supply pipe. Condensate has a very small volume compared to the steam, and this causes a pressure drop, which causes the steam to flow through the pipes. The steam generated in the boiler must be conveyed through pipework to the point where its heat energy is required. Initially there will be one or more main pipes, or 'steam mains', which carry steam from the boiler in the general direction of the steam using plant. Smaller branch pipes can then carry the steam to the individual pieces of equipment. A typical steam distribution system is shown in Figure 3.2.

#### The working pressure

The distribution pressure of steam is influenced by a number of factors, but is limited by:

- The maximum safe working pressure of the boiler
- The minimum pressure required at the plant

As steam passes through the distribution pipework, it will inevitably lose pressure due to:

- Frictional resistance within the pipework
- Condensation within the pipework as heat is transferred to the environment.

Therefore allowance should be made for this pressure loss when deciding upon the initial distribution pressure.

## Features of Steam Piping

General layout and location of steam consuming equipment is of great importance in efficient distribution of steam. Steam pipes should be laid by the shortest possible distance rather than to follow a building layout or road etc. However, this may come in the way of aesthetic design and architect's plans and a compromise may be necessary while laying new pipes.

Apart from proper sizing of pipe lines, provision must be made for proper draining of condensate which is bound to form as steam travels along the pipe.

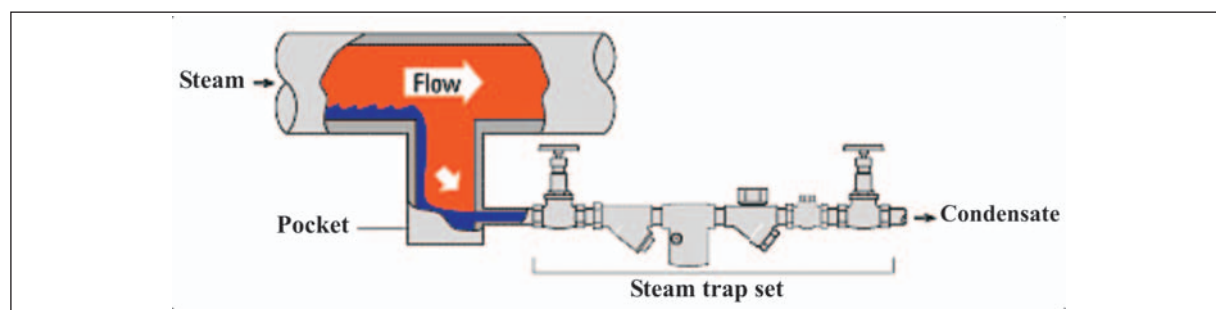

Figure 3.3 Draining Condensate from Mains

For example, a 100 mm well lagged pipe of 30-meter length carrying steam at 7 kg/cm<sup>2</sup> pressure can condense nearly 10 kg. of water in the pipe in one hour unless it is removed from the pipe through traps.

The pipes should run with a fall of not less than 12.5 mm in 3 meter in the direction of flow. There should also be large pockets in the pipes to enable water to collect otherwise water will be carried along with steam. These drain pockets should be provided at every 30 to 50 meters and at any low point in the pipe network. The pocket should be fitted with a trap to discharge the condensate. Necessary expansion loops are required to take care of the expansion of pipes when they get heated up. Automatic air vents should be fixed at the dead end of steam mains, which will allow removal of air which will tend to accumulate.

## 3.4 Steam Pipe Sizing and Design

Any modification and alteration in the existing steam piping, for supplying higher quality steam at right pressure and quantity must consider the following points:

### Pipe Sizing

The objective of the steam distribution system is to supply steam at the correct pressure to the point of use. It follows, therefore, that pressure drop through the distribution system is an important feature.

Proper sizing of steam pipelines help in minimizing pressure drop. The velocities for various types of steam are:

Superheated	50–70 m/sec
Saturated	30–40 m/sec
Wet or Exhaust	20–30 m/sec

For fluid flow to occur, there must be more energy at Point 1 than Point 2 (see Figure 3.4). The difference in energy is used to overcome frictional resistance between the pipe and the flowing fluid.

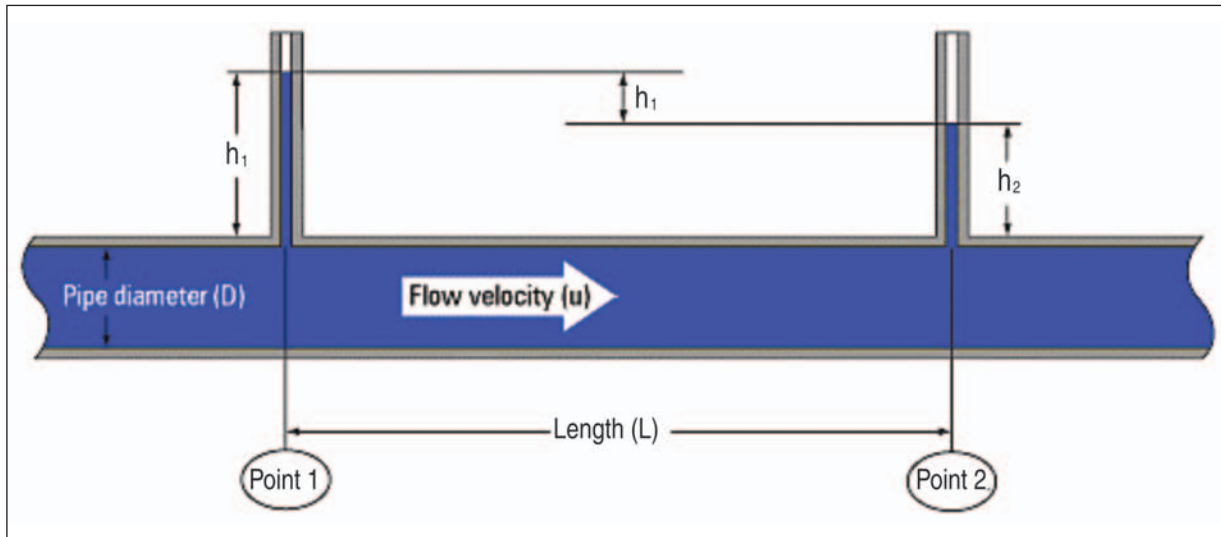

Figure 3.4 Pressure Drop in Steam Pipes

This is illustrated by the equation

$$h_f = \frac{4 f L u^2}{2 g D}$$

Where:

$h_f$  = Head loss to friction (m)

$f$  = Friction factor (dimensionless)

$L$  = Length (m)

$u$  = Flow velocity (m/s)

$g$  = Gravitational constant (9.81 m/s<sup>2</sup>)

$D$  = Pipe diameter (m)

It is useful to remember that:

- Head loss to friction ( $h_f$ ) is proportional to the velocity squared ( $u^2$ ).
- The friction factor ( $f$ ) is an experimental coefficient which is affected by factors including:
  - The Reynolds Number (which is affected by velocity).
  - The reciprocal of velocity<sup>2</sup>.

Because the values for 'f' are quite complex, they are usually obtained from charts.

### Example - Water pipe

Determine the difference in pressure between two points 1 km apart in a 150 mm bore horizontal pipework system. The water flowrate is 45 m<sup>3</sup>/h at 15°C and the friction factor for this pipe is taken as 0.005.

$$\text{Velocity (m/s)} = \frac{\text{Volume flowrate (m}^3/\text{s)}}{\text{Cross sectional area (m}^2\text{)}}$$

$$\text{Velocity} = \frac{45 \text{ m}^3/\text{h} \times 4}{3600 \text{ s/h} \times \pi \times 0.15^2}$$

$$\text{Velocity} = 0.71 \text{ m/s}$$

$$h_f = \frac{4f Lu^2}{2gD}$$

$$h_f = \frac{4 \times 0.005 \times 1000 \text{ m} \times 0.71^2}{2 \times 9.81 \times 0.15}$$

$$h_f = 3.43 \text{ m} \approx 0.34 \text{ bar}$$

#### Guide for proper drainage and layout of steam lines:

1. The steam mains should be run with a falling slope of not less than 125 mm for every 30 metres length in the direction of the steam flow.
2. Drain points should be provided at intervals of 30–45 metres along the main.
3. Drain points should also be provided at low points in the mains and where the steam main rises. Ideal locations are the bottom of expansion joints and before reduction and stop valves.
4. Drain points in the main lines should be through an equal tee connection only.
5. It is preferable to choose open bucket or TD traps on account of their resilience.
6. The branch lines from the mains should always be connected at the top. Otherwise, the branch line itself will act as a drain for the condensate.
7. Insecure supports as well as an alteration in level can lead to formation of water pockets in steam, leading to wet steam delivery. Providing proper vertical and support hangers helps overcome such eventualities.
8. Expansion loops are required to accommodate the expansion of steam lines while starting from cold.
9. To ensure dry steam in the process equipment and in branch lines, steam separators can be installed as required.

In practice whether for water pipes or steam pipes, a balance is drawn between pipe size and pressure loss. The steam piping should be sized, based on permissible velocity and the available pressure drop in the line. Selecting a higher pipe size will reduce the pressure drop and thus the energy cost. However, higher pipe size will increase the initial installation cost. By use of smaller pipe size, even though the installation cost can be reduced, the energy cost will increase due to higher-pressure drop. It is to be noted that the pressure drop change will be inversely proportional to the 5th power of diameter change. Hence, care should be taken in selecting the optimum pipe size.

### Pipe Redundancy

All redundant (piping which are no longer needed) pipelines must be eliminated, which could be, at times, upto 10–15 % of total length. This could reduce steam distribution losses significantly. The pipe routing shall be made for transmission of steam in the shortest possible way, so as to reduce the pressure drop in the system, thus saving the energy. However, care should be taken that, the pipe routing shall be flexible enough to take thermal expansion and to keep the terminal point loads, within the allowable limit.

## 3.5 Proper Selection, Operation and Maintenance of Steam Traps

The purpose of installing the steam traps is to obtain fast heating of the product and equipment by keeping the steam lines and equipment free of condensate, air and non-condensable gases. A steam trap is a valve device that discharges condensate and air from the line or piece of equipment without discharging the steam.

### Functions of Steam Traps

The three important functions of steam traps are:

- To discharge condensate as soon as it is formed.
- Not to allow steam to escape.
- To be capable of discharging air and other incondensable gases.

### Types of Steam Traps

There are three basic types of steam trap into which all variations fall, all three are classified by International Standard ISO 6704:1982.

**Thermostatic (operated by changes in fluid temperature)** - The temperature of saturated steam is determined by its pressure. In the steam space, steam gives up its enthalpy of evaporation (heat), producing condensate at steam temperature. As a result of any further heat loss, the temperature of the condensate will fall. A thermostatic trap will pass condensate when this lower temperature is sensed. As steam reaches the trap, the temperature increases and the trap closes.

**Mechanical (operated by changes in fluid density)** - This range of steam traps operates by sensing the difference in density between steam and condensate. These steam traps include 'ball float traps' and 'inverted bucket traps'. In the 'ball float trap', the ball rises in the presence of condensate, opening a valve which passes the denser condensate. With the 'inverted bucket



trap', the inverted bucket floats when steam reaches the trap and rises to shut the valve. Both are essentially 'mechanical' in their method of operation.

**Thermodynamic (operated by changes in fluid dynamics)** - Thermodynamic steam traps rely partly on the formation of flash steam from condensate. This group includes 'thermodynamic', 'disc', 'impulse' and 'labyrinth' steam traps.

Some of the important traps in industrial use are explained as follows:

### Inverted Bucket

The inverted bucket steam trap is shown in Figure 3.5. As its name implies, the mechanism consists of an inverted bucket which is attached by a lever to a valve. An essential part of the trap is the small air vent hole in the top of the bucket. Figure 3.5 shows the method of operation. In (i) the bucket hangs down, pulling the valve off its seat. Condensate flows under the bottom of the bucket filling the body and flowing away through the outlet. In (ii) the arrival of steam causes the bucket to become buoyant, it then rises and shuts the outlet. In (iii) the trap remains shut until the steam in the bucket has condensed or bubbled through the vent hole to the top of the trap body. It will then sink, pulling the main valve off its seat. Accumulated condensate is released and the cycle is repeated.

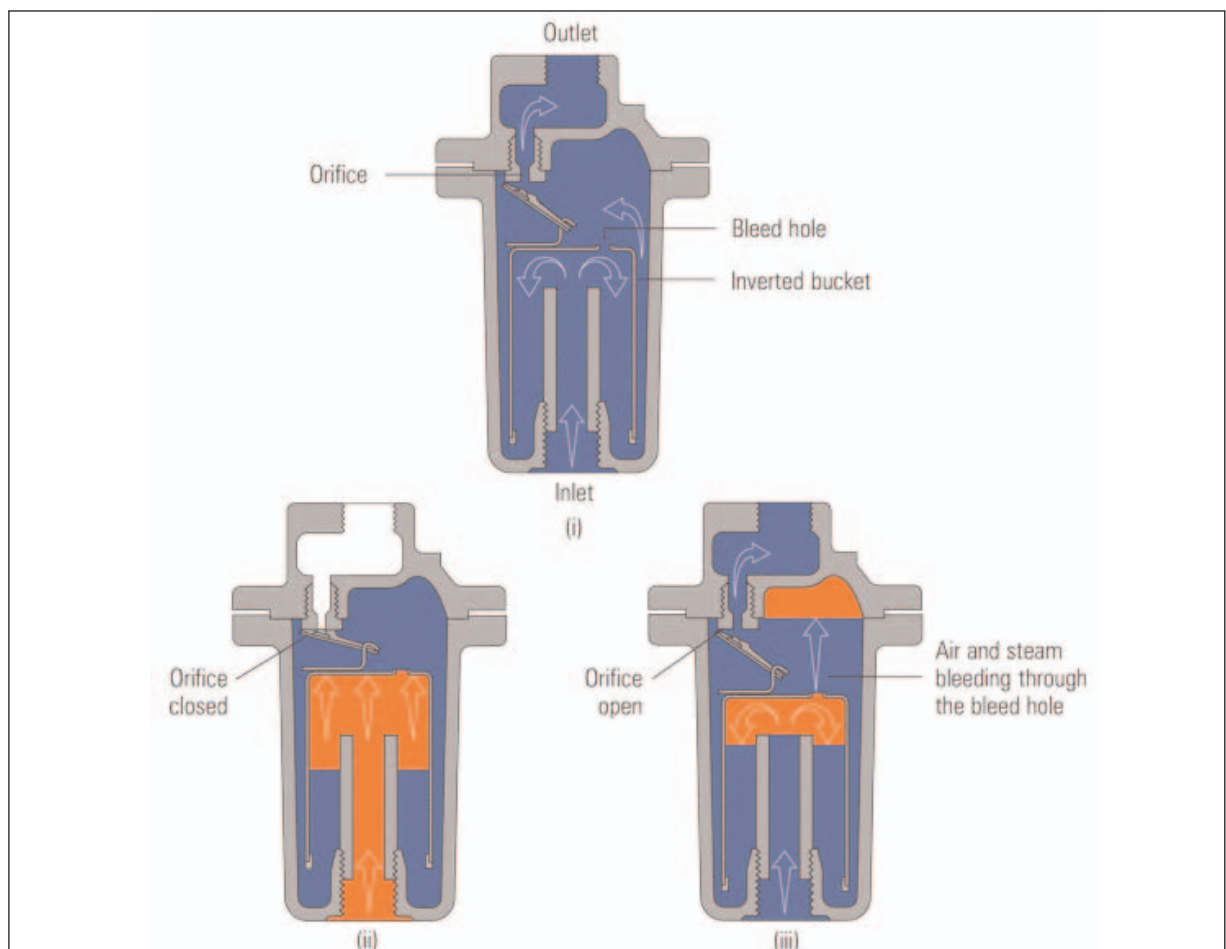

Figure 3.5 Inverted Bucket Trap

In (ii), air reaching the trap at start-up will also give the bucket buoyancy and close the valve. The bucket vent hole is essential to allow air to escape into the top of the trap for eventual discharge through the main valve seat. The hole, and the pressure differential, are small so the trap is relatively slow at venting air. At the same time it must pass (and therefore waste) a certain amount of steam for the trap to operate once the air has cleared. A parallel air vent fitted outside the trap will reduce start-up times.

### **Advantages of the inverted bucket steam trap**

- The inverted bucket steam trap can be made to withstand high pressures.
- Like a float-thermostatic steam trap, it has a good tolerance to waterhammer conditions.
- Can be used on superheated steam lines with the addition of a check valve on the inlet.
- Failure mode is usually open, so it's safer on those applications that require this feature, for example turbine drains.

### **Disadvantages of the inverted bucket steam trap**

- The small size of the hole in the top of the bucket means that this type of trap can only discharge air very slowly. The hole cannot be enlarged, as steam would pass through too quickly during normal operation.
- There should always be enough water in the trap body to act as a seal around the lip of the bucket. If the trap loses this water seal, steam can be wasted through the outlet valve. This can often happen on applications where there is a sudden drop in steam pressure, causing some of the condensate in the trap body to 'flash' into steam. The bucket loses its buoyancy and sinks, allowing live steam to pass through the trap orifice. Only if sufficient condensate reaches the trap will the water seal form again, and prevent steam wastage.

### **Float and Thermostatic**

The ball float type trap operates by sensing the difference in density between steam and condensate. In the case of the trap shown in Figure 3.6A, condensate reaching the trap will cause the ball float to rise, lifting the valve off its seat and releasing condensate. As can be seen, the valve is always flooded and neither steam nor air will pass through it, so early traps of this kind were vented using a manually operated cock at the top of the body. Modern traps use a thermostatic air vent, as shown in Figure 3.6B. This allows the initial air to pass whilst the trap is also handling condensate.

The automatic air vent uses the same balanced pressure capsule element as a thermostatic steam trap, and is located in the steam space above the condensate level. After releasing the initial air, it remains closed until air or other non-condensable gases accumulate during normal running and cause it to open by reducing the temperature of the air/steam mixture. The thermostatic air vent offers the added benefit of significantly increasing condensate capacity on cold start-up.

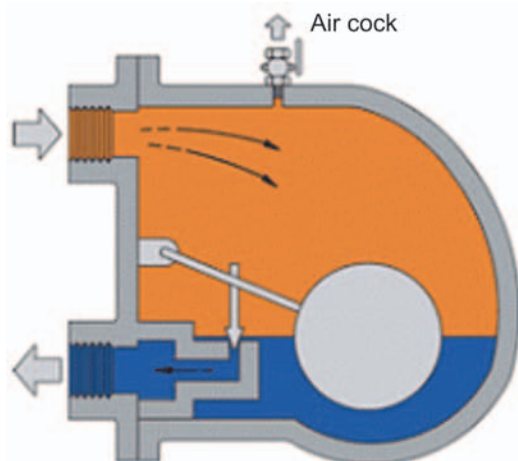

Figure 3.6A Float Trap with Air Cock

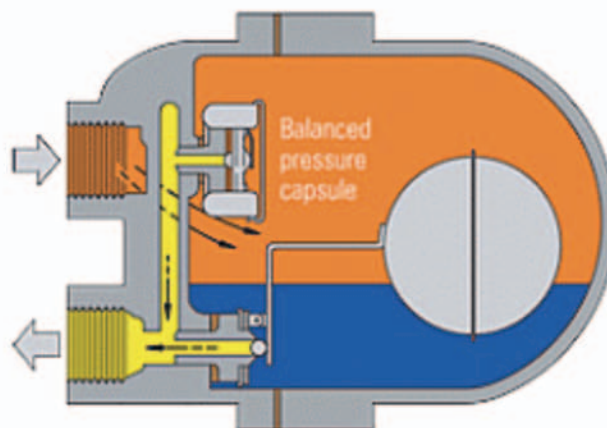

Figure 3.6B Float Trap with Thermostatic Air Vent

In the past, the thermostatic air vent was a point of weakness if waterhammer was present in the system. Even the ball could be damaged if the waterhammer was severe. However, in modern float traps the air vent is a compact, very robust, all stainless steel capsule, and the modern welding techniques used on the ball makes the complete float-thermostatic steam trap very robust and reliable in waterhammer situations.

In many ways the float-thermostatic trap is the closest to an ideal steam trap. It will discharge condensate as soon as it is formed, regardless of changes in steam pressure.

#### Advantages of the float-thermostatic steam trap

- The trap continuously discharges condensate at steam temperature. This makes it the first choice for applications where the rate of heat transfer is high for the area of heating surface available.
- It is able to handle heavy or light condensate loads equally well and is not affected by wide and sudden fluctuations of pressure or flowrate.
- As long as an automatic air vent is fitted, the trap is able to discharge air freely.
- It has a large capacity for its size.
- The versions which have a steam lock release valve are the only type of trap entirely suitable for use where steam locking can occur.
- It is resistant to waterhammer.

#### Disadvantages of the float-thermostatic steam trap

- Although less susceptible than the inverted bucket trap, the float type trap can be damaged by severe freezing and the body should be well lagged, and / or complemented with a small supplementary thermostatic drain trap, if it is to be fitted in an exposed position.
- As with all mechanical type traps, different internals are required to allow operation over varying pressure ranges. Traps operating on higher differential pressures have smaller orifices to balance the buoyancy of the float.

## Thermodynamic

The thermodynamic trap is an extremely robust steam trap with a simple mode of operation.

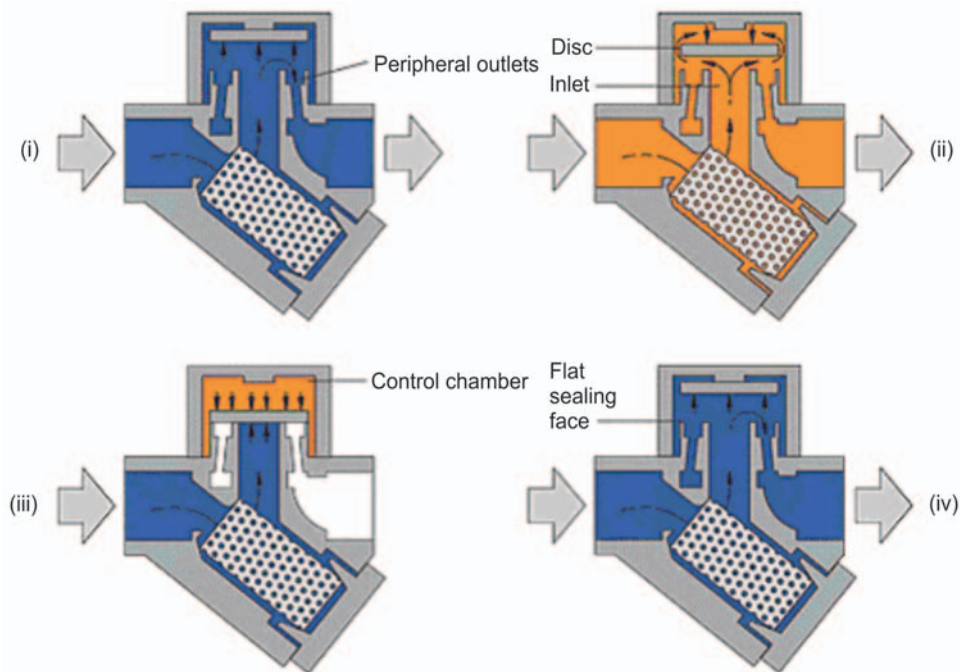

Figure 3.7 Thermodynamic Trap

The trap operates by means of the dynamic effect of flash steam as it passes through the trap, as depicted in Figure 3.7. The only moving part is the disc above the flat face inside the control chamber or cap.

On start-up, incoming pressure raises the disc, and cool condensate plus air is immediately discharged from the inner ring, under the disc, and out through three peripheral outlets (only 2 shown, Figure 3.7, i)

Hot condensate flowing through the inlet passage into the chamber under the disc drops in pressure and releases flash steam moving at high velocity. This high velocity creates a low pressure area under the disc, drawing it towards its seat (Figure 3.7, ii).

At the same time, the flash steam pressure builds up inside the chamber above the disc, forcing it down against the incoming condensate until it seats on the inner and outer rings. At this point, the flash steam is trapped in the upper chamber, and the pressure above the disc equals the pressure being applied to the underside of the disc from the inner ring. However, the top of the disc is subject to a greater force than the underside, as it has a greater surface area.

Eventually the trapped pressure in the upper chamber falls as the flash steam condenses. The disc is raised by the now higher condensate pressure and the cycle repeats (Figure 3.7, iv).

## Thermostatic

Thermal-element thermostatic traps are temperature actuated. On startup the thermal element is in a contracted position with the valve wide-open, purging condensate, air, and other noncondensable gases. As the system warms up, heat generates pressure in the thermal element, causing it to expand and throttle the flow of hot condensate through the discharge valve.

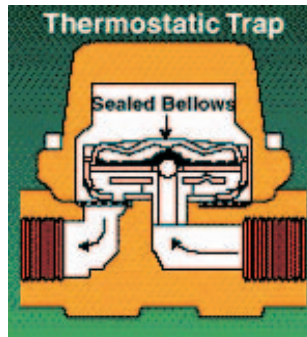

**Figure 3.8 Thermostatic Trap**

When steam follows the hot condensate into the trap, the thermal element fully expands, closing the trap. If condensate enters the trap during system operation, it cools the element, contracting it off the seat, and quickly discharging condensate (Figure 3.8).

Thermostatic traps are small, lightweight, and compact. One trap operates over extremely broad pressure and capacity ranges. Thermal elements can be selected to operate within a range of steam temperatures. In steam tracing applications it may be desirable to actually back up hot condensate in the lines to extract its thermal value.

### **Bimetallic Type**

Bimetallic steam traps operate on the same principle as a heating thermostat. A bimetallic strip or wafer connected to a valve bends or distorts when subjected to a change in temperature. When properly calibrated, the valve closes off against a seat when steam is present, and opens when condensate, air, and other noncondensable gases are present (Figure 3.9).

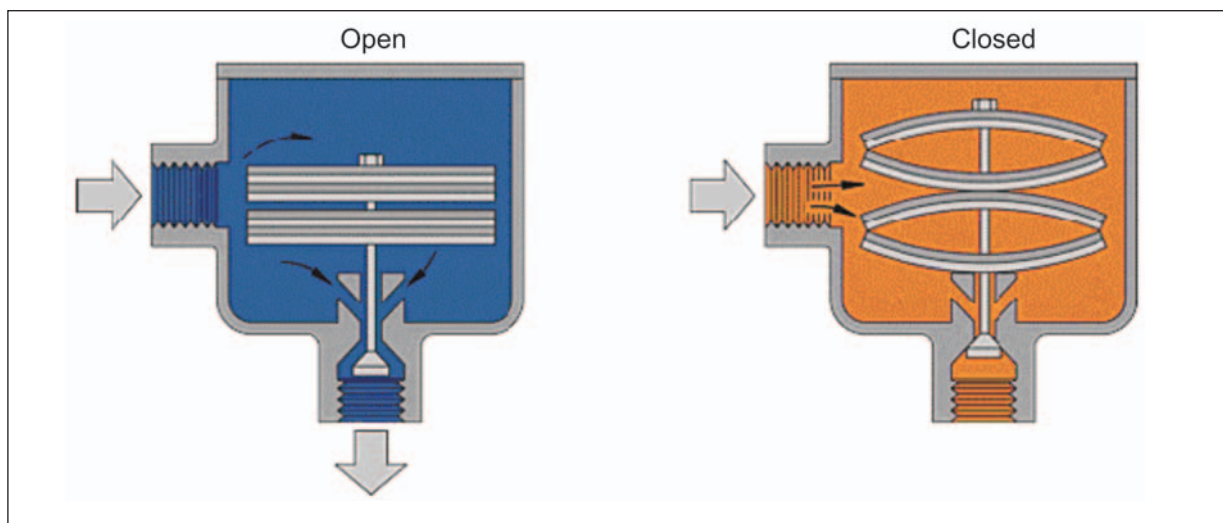

**Figure 3.9 Bimetallic Type**

### **Advantages of the bimetallic steam trap**

- relatively small size for the condensate loads they handle
- resistance to damage from water hammer

A disadvantage is that they must be set, generally at the plant, for a particular steam operating pressure. If the trap is used for a lower pressure, it may discharge live steam. If used at a higher steam pressure, it can back up condensate into the system.

Thermostatic traps are often considered a universal steam trap; however, they are normally not recommended for extremely high condensate requirements (over 7000 kg/hr). For light-to-moderately high condensate loads, thermostatic steam traps offer advantages in terms of initial cost, long-term energy conservation, reduced inventory, and ease in application and maintenance.

### Installation of Steam Traps

In most cases, trapping problems are caused by bad installation rather than by the choice of the wrong type or faulty manufacture. To ensure a trouble-free installation, careful consideration should be given to the drain point, pipe sizing, air venting, steam locking, group trapping vs. individual trapping, dirt, water hammer, lifting of the condensate, etc.

#### 1) Drain Point

The drain point should be so arranged that the condensate can easily flow into the trap. This is not always appreciated. For example, it is useless to provide a 15 mm drain hole in the bottom of a 150 mm steam main, because most of the condensate will be carried away by the steam velocity. A proper pocket at the lowest part of the pipe line into which the condensate can drop of at least 100 mm diameter is needed in such cases.

Figures 3.10A and 3.10B show the wrong and the correct practices in providing the drain points on the steam lines.

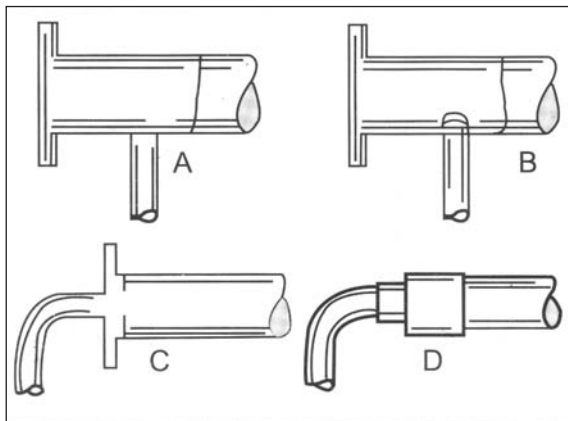

Figure 3.10A Wrong ways of Draining Pipes

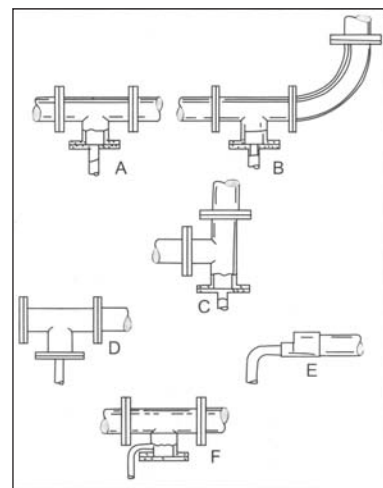

Figure 3.10B Right ways of Draining Pipes

#### 2) Pipe Sizing

The pipes leading to and from steam traps should be of adequate size. This is particularly important in the case of thermodynamic traps, because their correct operation can be disturbed by excessive resistance to flow in the condensate pipe work. Pipe fittings such as valves, bends and tees close to the trap will also set up excessive backpressures in certain circumstances.

### 3) Air Binding

When air is pumped into the trap space by the steam, the trap function ceases. Unless adequate provision is made for removing air either by way of the steam trap or a separate air vent, the plant may take a long time in warming up and may never give its full output.

### 4) Steam Locking

This is similar to air binding except that the trap is locked shut by steam instead of air. The typical example is a drying cylinder. It is always advisable to use a float trap provided with a steam lock release arrangement.

### 5) Group Trapping vs. Individual Trapping

It is tempting to try and save money by connecting several units to a common steam trap as shown in Figure 3.11A. This is known as group trapping. However, it is rarely successful, since it normally causes water-logging and loss of output.

The steam consumption of a number of units is never the same at a moment of time and therefore, the pressure in the various steam spaces will also be different. It follows that the pressure at the drain outlet of a heavily loaded unit will be less than in the case of one that is lightly or properly loaded. Now, if all these units are connected to a common steam trap, the condensate from the heavily loaded and therefore lower pressure steam space finds it difficult to reach the trap as against the higher pressure condensate produced by lightly or partly loaded unit. The only satisfactory arrangement, thus would be to drain each steam space with own trap and then connect the outlets of the various traps to the common condensate return main as shown in above Figure 3.11B.

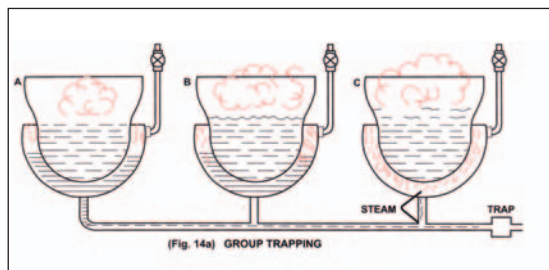

Figure 3.11A Group Trapping

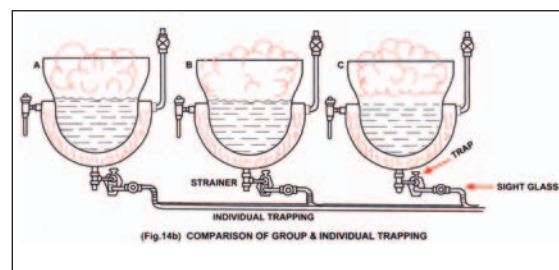

Figure 3.11B Individual Trapping

### 6) Dirt

Dirt is the common enemy of steam traps and the causes of many failures. New steam systems contain scale, castings, weld metal, piece of packing and jointing materials, etc. When the system has been in use for a while, the inside of the pipe work and fittings, which is exposed to corrosive condensate can get rusted. Thus, rust in the form of a fine brown powder is also likely to be present. All this dirt will be carried through the system by the steam and condensate until it reaches the steam trap. Some of it may pass through the trap into the condensate system without doing any harm, but some dirt will eventually jam the trap mechanism. It is advisable to use a strainer positioned before the steam trap to prevent dirt from passing into the system.

## 7) Water Hammer

A water hammer (Figure 3.12) in a steam system is caused by condensate collection in the plant or pipe work picked up by the fast moving steam and carried along with it. When this collection hits obstructions such as bends, valves, steam traps or some other pipe fittings, it is likely to cause severe damage to fittings and equipment and result in leaking pipe joints.

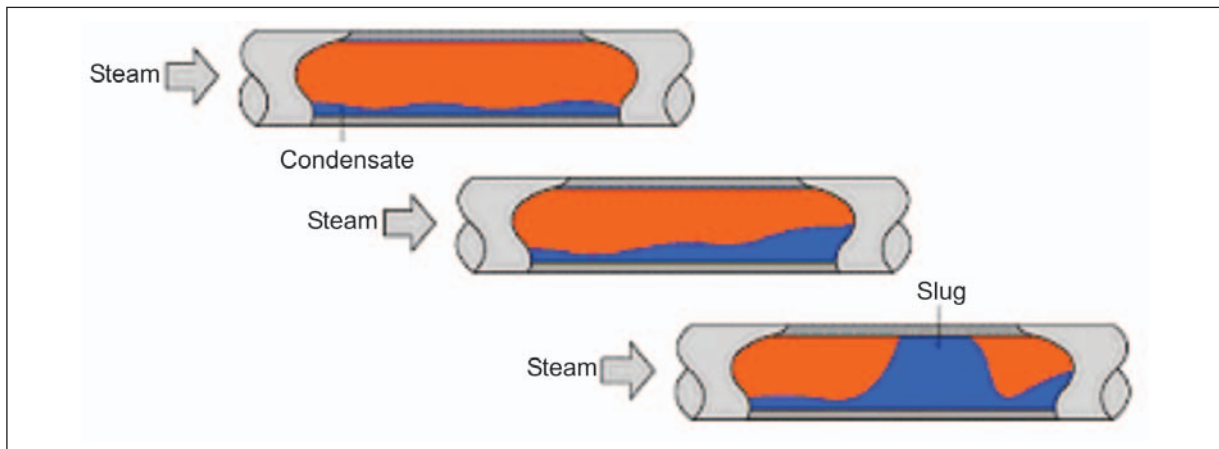

**Figure 3.12 Water Hammer**

The problem of water hammer can be eliminated by positioning the pipes so that there is a continuous slope in the direction of flow. A slope of at least 12 mm in every 3 metres is necessary, as also an adequate number of drain points every 30 to 50 metres.

## 8) Lifting the Condensate

It is sometimes necessary to lift condensate from a steam trap to a higher level condensate return line (Figure 3.13). The condensate will rise up the lifting pipework when the steam pressure upstream of the trap is higher than the pressure downstream of the trap.

The pressure downstream of the trap is generally called backpressure, and is made up of any pressure existing in the condensate line plus the static lift caused by condensate in the rising pipework. The upstream pressure will vary between start-up conditions, when it is at its lowest, and running conditions, when it is at its highest.

Backpressure is related to lift by using the following approximate conversion: 1 metre lift in pipework = 1m head static pressure or 0.1 bar backpressure.

If a head of 5 m produces a backpressure of 0.5 bar, then this reduces the differential pressure available to push condensate through the trap; although under running conditions the reduction in trap capacity is likely to be significant only where low upstream pressures are used.

In steam mains at start-up, the steam pressure is likely to be very low, and it is common for water to back-up before the trap, which can lead to waterhammer in the space being drained. To alleviate this problem at start-up, a liquid expansion trap, fitted as shown in Figure 3.13, will discharge any cold condensate formed at this time to waste.

As the steam main is warmed, the condensate temperature rises, causing the liquid expansion trap to close. At the same time, the steam pressure rises, forcing the hot condensate



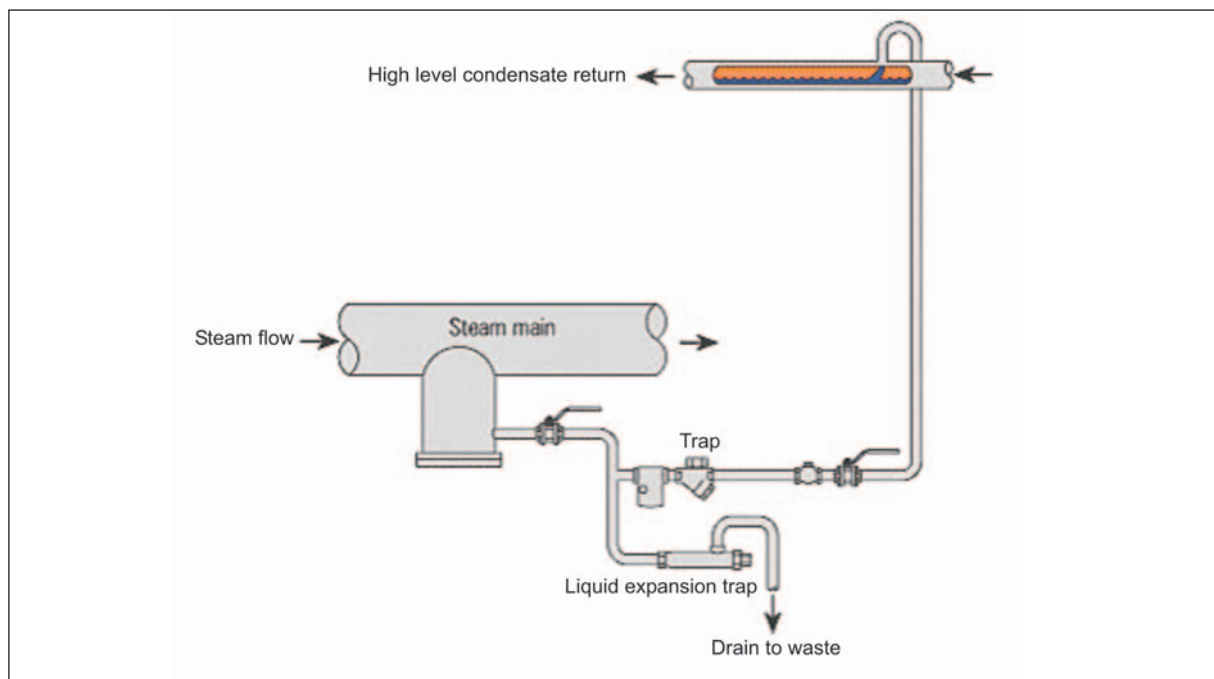

**Figure 3.13 Use of a liquid Expansion Trap**

through the 'working' drain trap to the return line.

The discharge line from the trap to the overhead return line, preferably discharges into the top of the main rather than simply feed to the underside, as shown in Figure 3.13. This assists operation, because although the riser is probably full of water at start-up, it sometimes contains little more than flash steam once hot condensate under pressure passes through. If the discharge line were fitted to the bottom of the return line, it would fill with condensate after each discharge and increase the tendency for waterhammer and noise.

It is also recommended that a check valve be fitted after any steam trap from where condensate is lifted, preventing condensate from falling back towards the trap.

The above general recommendations apply not just to traps lifting condensate from steam mains, but also to traps draining any type of process running at a constant steam pressure. Temperature controlled processes will often run with low steam pressures. Rising condensate discharge lines should be avoided at all costs, unless automatic pump-traps are used.

### **Maintenance of Steam Traps**

Dirt is one of the most common causes of steam traps blowing steam. Dirt and scale are normally found in all steam pipes. Bits of jointing material are also quite common. Since steam traps are connected to the lowest parts of the system, sooner or later this foreign matter finds its way to the trap. Once some of the dirt gets logged in the valve seat, it prevents the valve from shutting down tightly thus allowing steam to escape. The valve seal should therefore be quickly cleaned, to remove this obstruction and thus prevent steam loss.

In order to ensure proper working, steam traps should be kept free of pipe-scale and dirt. The best way to prevent the scale and dirt from getting into the trap is to fit a strainer. Strainer (Figure 3.14) is a detachable, perforated or meshed screen enclosed in a metal body. It should be borne in mind that the strainer collects dirt in the course of time and will therefore need

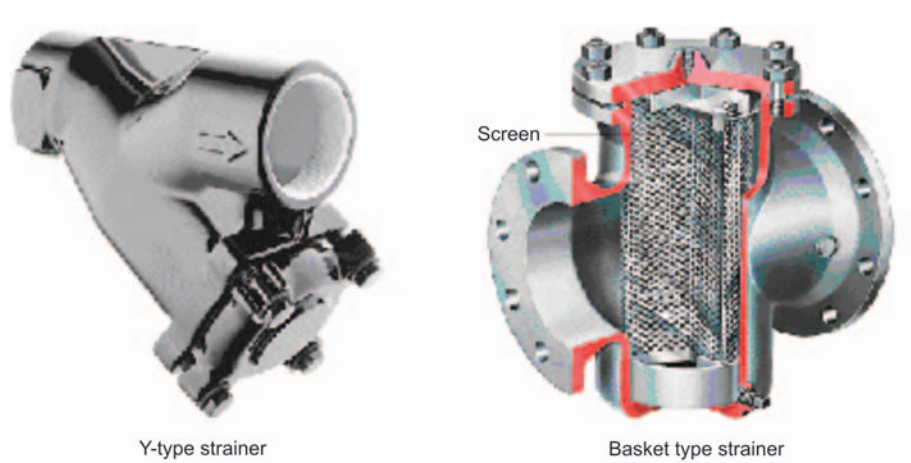

**Figure 3.14 Strainers**

periodic cleaning. It is of course, much easier to clean a strainer than to overhaul a steam trap. At this point, we might mention the usefulness of a sight glass fitted just after a steam trap. Sight glasses are useful in ascertaining the proper functioning of traps and in detecting leaking steam traps. In particular, they are of considerable advantage when a number of steam traps are discharging into a common return line. If it is suspected that one of the traps is blowing steam, it can be quickly identified by looking through the sight glass.

In most industries, maintenance of steam traps is not a routine job and is neglected unless it leads to some definite trouble in the plant. In view of their importance as steam savers and to monitor plant efficiency, the steam traps require considerably more care than is given.

One may consider a periodic maintenance schedule to repair and replace defective traps in the shortest possible time, preferable during regular maintenance shut downs in preference to break down repairs.

### **Guide to Steam Trap Selection**

Actual energy efficiency can be achieved only when

- a. Selection
- b. Installation and
- c. Maintenance of steam traps meet the requirements for the purpose it is installed.

The following Table 3.2 gives installation of suitable traps for different process applications.

<b>TABLE 3.2 SELECTION OF STEAM TRAP</b>		
<b>Application</b>	<b>Feature</b>	<b>Suitable trap</b>
Steam mains	<ul style="list-style-type: none"> <li>– Open to atmosphere, small capacity</li> <li>– Frequent change in pressure</li> <li>– Low pressure - high pressure</li> </ul>	Thermodynamic type
Equipment <ul style="list-style-type: none"> <li>• Reboiler</li> <li>• Heater</li> <li>• Dryer</li> <li>• Heat exchanger etc.</li> </ul>	<ul style="list-style-type: none"> <li>– Large capacity</li> <li>– Variation in pressure and temperature is undesirable</li> <li>– Efficiency of the equipment is a problem</li> </ul>	Mechanical trap, Bucket,, Inverted bucket, float
<ul style="list-style-type: none"> <li>• Tracer line</li> <li>• Instrumentation</li> </ul>	– Reliability with no over heating	Thermodynamic & Bimetallic

### 3.6 Performance Assessment Methods for Steam Traps

Steam trap performance assessment is basically concerned with answering the following two questions:

- Is the trap working correctly or not?
- If not, has the trap failed in the open or closed position?

Traps that fail 'open' result in a loss of steam and its energy. Where condensate is not returned, the water is lost as well. The result is significant economic loss, directly via increased boiler plant costs, and potentially indirectly, via decreased steam heating capacity.

Traps that fail 'closed' do not result in energy or water losses, but can result in significantly reduced heating capacity and/or damage to steam heating equipment.

#### Visual Testing

Visual testing includes traps with open discharge, sight glasses (Figure 3.15), sight checks, test tees and three way test valves. In every case, the flow or variation of flow is visually observed. This method works well with traps that cycle on/off, or dribble on light load. On high flow or

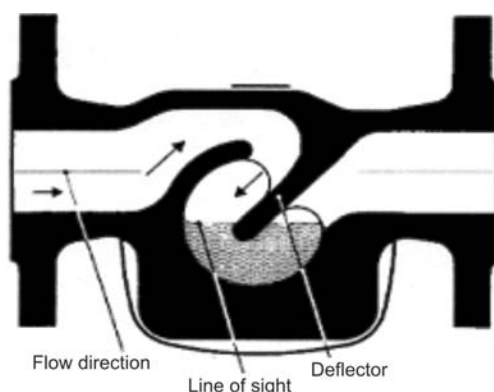

**Figure 3.15 Sight Glass**

process, due to the volume of water and flash steam, this method becomes less viable. If condensate can be diverted ahead of the trap or a secondary flow can be turned off, the load on the trap will drop to zero or a very minimal amount so the visual test will allow in determining the leakage.

### Sound Testing

Sound testing includes ultrasonic leak detectors (Figure 3.16), mechanics stethoscopes, screwdriver or metal rod with a human ear against it. All these use the sound created by flow to determine the trap function like the visual method. This method works best with traps that cycle on/off or dribble on light load. Traps which have modulating type discharge patterns are hard to check on high flows. (examples are processes , heat exchangers, air handling coils, etc). Again by diverting condensate flow ahead of the trap or shutting off a secondary flow as mentioned under visual testing, the noise level will drop to zero or a very low level if the trap is operating correctly. If the trap continues to flow heavily after diversion it would be leaking or blowing through.



Figure 3.16 Ultrasonic Testing

### Temperature Testing

Temperature testing includes infrared guns (Figure 3.17), surface pyrometers, temperature tapes, and temperature crayons. Typically they are used to gauge the discharge temperature on



Figure 3.17 Infra Red Testing

the outlet side of the trap. In the case of temperature tapes or crayon, they are set for a predetermined temperature and they indicate when temperature exceeds that level. Infrared guns and surface pyrometer can detect temperatures on both sides of the trap. Both the infrared and surface pyrometers require bare pipe and a clean surface to achieve a reasonable reading. The temperature reading will typically be lower than actual internal pipe temperature due to the fact that steel does have some heat flow resistance. Scale on the inside of the pipe can also effect the heat transfer. Some of the more expensive infrared guns can compensate for wall thickness and material differences. Blocked or turned off traps can easily be detected by infrared guns and surface pyrometers, as they will show low or cold temperatures. They could also pick up traps which may be undersized or backing up large amounts of condensate by detecting low temperature readings.

### 3.7 Energy Saving Opportunities

#### 1. Monitoring Steam Traps

For testing a steam trap, there should be an isolating valve provided in the downstream of the trap and a test valve shall be provided in the trap discharge. When the test valve is opened, the following points have to be observed:

**Condensate discharge**—Inverted bucket and thermodynamic disc traps should have intermittent condensate discharge. Float and thermostatic traps should have a continuous condensate discharge. Thermostatic traps can have either continuous or intermittent discharge depending upon the load. If inverted bucket traps are used for extremely small load, it will have a continuous condensate discharge.

**Flash steam**—This shall not be mistaken for a steam leak through the trap. The users sometimes get confused between a flash steam and leaking steam. The flash steam and the leaking steam can be approximately identified as follows:

- If steam blows out continuously in a blue stream, it is a leaking steam.
- If a steam floats out intermittently in a whitish cloud, it is a flash steam.

#### 2. Continuous steam blow and no flow indicate, there is a problem in the trap

Whenever a trap fails to operate and the reasons are not readily apparent, the discharge from the trap should be observed. A step-by-step analysis has to be carried out mainly with reference to lack of discharge from the trap, steam loss, continuous flow, sluggish heating, to find out whether it is a system problem or the mechanical problem in the steam trap.

#### 3. Avoiding Steam Leakages

Steam leakage is a visible indicator of waste and must be avoided. It has been estimated that a 3 mm diameter hole on a pipeline carrying 7 kg/cm<sup>2</sup> steam would waste 33 KL of fuel oil per year. Steam leaks on high-pressure mains are prohibitively costlier than on low pressure mains. Any steam leakage must be quickly attended to. In fact, the plant should consider a regular surveillance programme for identifying leaks at pipelines, valves, flanges and joints. Indeed, by plugging all leakages, one may be surprised at the extent of fuel savings, which may reach up

to 5% of the steam consumption in a small or medium scale industry or even higher in installations having several process departments.

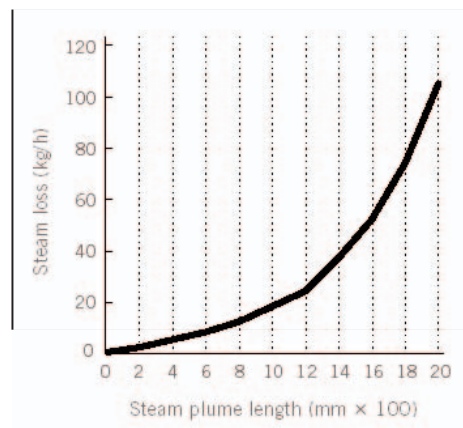

**Figure 3.18 Steam Loss vs. Plume Length**

To avoid leaks it may be worthwhile considering replacement of the flanged joints which are rarely opened in old plants by welded joints. Figure 3.18 provides a quick estimate for steam leakage based on plume length.

#### Example

- Plume Length = 700 mm
- Steam loss = 10 kg/h

#### 4. Providing Dry Steam for Process

The best steam for industrial process heating is the dry saturated steam. Wet steam reduces total heat in the steam. Also water forms a wet film on heat transfer and overloads traps and condensate equipment. Super heated steam is not desirable for process heating because it gives up heat at a rate slower than the condensation heat transfer of saturated steam.

It must be remembered that a boiler without a superheater cannot deliver perfectly dry saturated steam. At best, it can deliver only 95% dry steam. The dryness fraction of steam depends on various factors, such as the level of water to be a part of the steam. Indeed, even as simple a thing as improper boiler water treatment can become a cause for wet steam.

As steam flows through the pipelines, it undergoes progressive condensation due to the loss of heat to the colder surroundings, The extent of the condensation depends on the effectiveness of the lagging. For example, with poor lagging, the steam can become excessively wet.

Since dry saturated steam is required for process equipment, due attention must be paid to the boiler operation and lagging of the pipelines.

Wet steam can reduce plant productivity and product quality, and can cause damage to most items of plant and equipment. Whilst careful drainage and trapping can remove most of the water, it will not deal with the water droplets suspended in the steam. To remove these suspended water droplets, separators are installed in steam pipelines.

The steam produced in a boiler designed to generate saturated steam is inherently wet. Although the dryness fraction will vary according to the type of boiler, most shell type steam boilers will produce steam with a dryness fraction of between 95 and 98%. The water content of the steam produced by the boiler is further increased if priming and carryover occur.

A steam separator (Refer Figure 3.19) may be installed on the steam main as well as on the branch lines to reduce wetness in steam and improve the quality of the steam going to the units. By change of direction of steam, steam separators causes the entrained water particles to be separated out and delivered to a point where they can be drained away as condensate through a conventional steam trap. A few types of separators are illustrated in the Figure below.

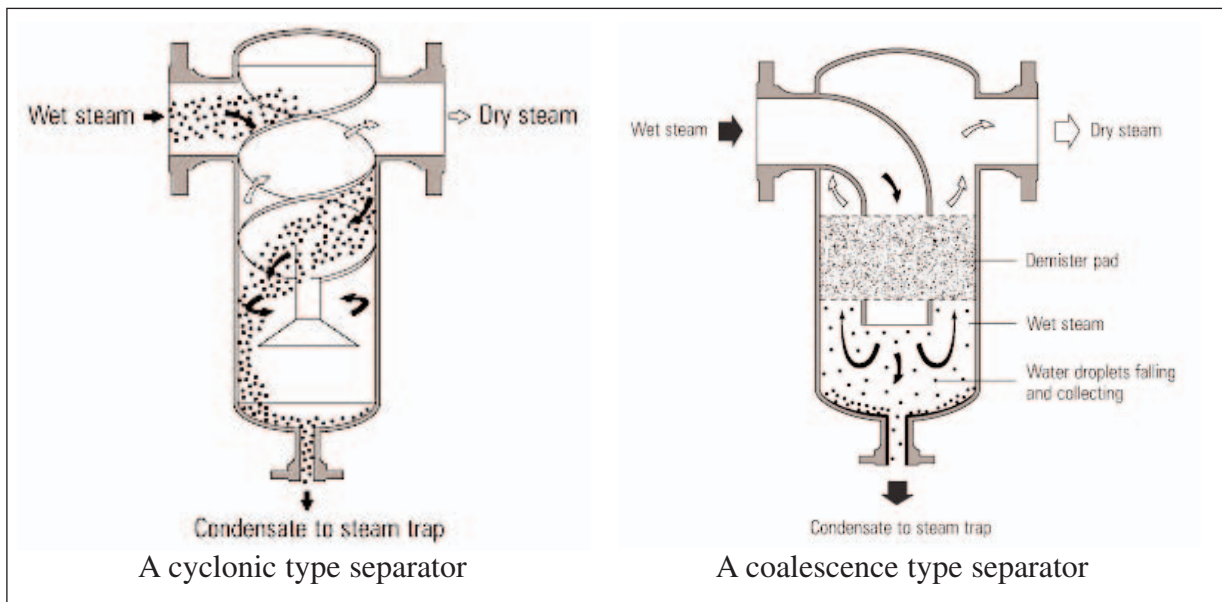

Figure 3.19 Steam Separators

## 5. Utilising Steam at the Lowest Acceptable Pressure for the Process

A study of the steam tables would indicate that the latent heat in steam reduces as the steam pressure increases. It is only the latent heat of steam, which takes part in the heating process when applied to an indirect heating system. Thus, it is important that its value be kept as high as possible. This can only be achieved if we go in for lower steam pressures. As a guide, the steam should always be generated and distributed at the highest possible pressure, but utilized at as low a pressure as possible since it then has higher latent heat.

However, it may also be seen from the steam tables that the lower the steam pressure, the lower will be its temperature. Since temperature is the driving force for the transfer of heat at lower steam pressures, the rate of heat transfer will be slower and the processing time greater. In equipment where fixed losses are high (e.g. big drying cylinders), there may even be an increase in steam consumption at lower pressures due to increased processing time. There are, however, several equipment in certain industries where one can profitably go in for lower pressures and realize economy in steam consumption without materially affecting production time.

Therefore, there is a limit to the reduction of steam pressure. Depending on the equipment design, the lowest possible steam pressure with which the equipment can work should be selected without sacrificing either on production time or on steam consumption.

## 6. Proper Utilization of Directly Injected Steam

The heating of a liquid by direct injection of steam is often desirable. The equipment required is relatively simple, cheap and easy to maintain. No condensate recovery system is necessary. The heating is quick, and the sensible heat of the steam is also used up along with the latent heat, making the process thermally efficient. In processes where dilution is not a problem, heating is done by blowing steam into the liquid (i.e.) direct steam injection is applied. If the dilution of the tank contents and agitation are not acceptable in the process (i.e.) direct steam agitation are not acceptable, indirect steam heating is the only answer.

Ideally, the injected steam should be condensed completely as the bubbles rise through the liquid. This is possible only if the inlet steam pressures are kept very low-around  $0.5 \text{ kg/cm}^2$  -and certainly not exceeding  $1 \text{ kg/cm}^2$ . If pressures are high, the velocity of the steam bubbles will also be high and they will not get sufficient time to condense before they reach the surface. Figure 3.20 shows a recommended arrangement for direct injection of steam.

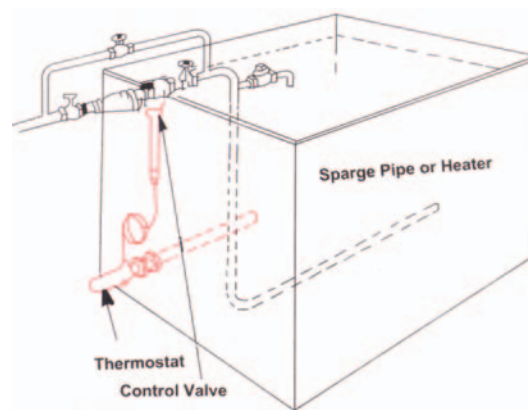

**Figure 3.20 Recommended Arrangement for Directly Injected Steam**

A large number of small diameter holes (2 to 5 mm), facing downwards, should be drilled on the separate pipe. This will help in dissipating the velocity of bubbles in the liquid. A thermostatic control of steam admitted is highly desirable.

## 7. Minimising Heat Transfer Barriers

The metal wall may not be the only barrier in a heat transfer process. There is likely to be a film of air, condensate and scale on the steam side. On the product side there may also be baked-on product or scale, and a stagnant film of product.

Agitation of the product may eliminate the effect of the stagnant film, whilst regular cleaning on the product side should reduce the scale.



Regular cleaning of the surface on the steam side may also increase the rate of heat transfer by reducing the thickness of any layer of scale, however, this may not always be possible. This layer may also be reduced by careful attention to the correct operation of the boiler, and the removal of water droplets carrying impurities from the boiler.

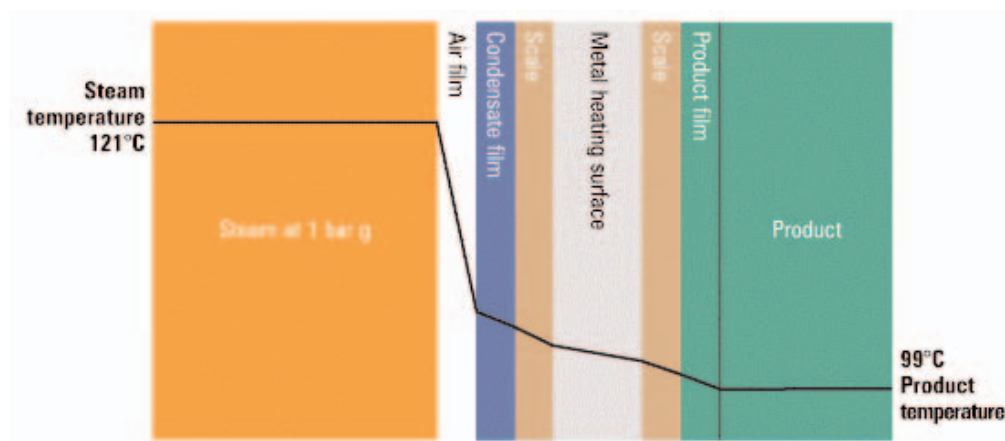

Figure 3.21

### Filmwise Condensation

The elimination of the condensate film, is not quite as simple. As the steam condenses to give up its enthalpy of evaporation, droplets of water may form on the heat transfer surface. These may then merge together to form a continuous film of condensate. The condensate film may be between 100 and 150 times more resistant to heat transfer than a steel heating surface, and 500 to 600 times more resistant than copper.

### Dropwise Condensation

If the droplets of water on the heat transfer surface do not merge immediately and no continuous condensate film is formed, 'dropwise' condensation occurs. The heat transfer rates which can be achieved during dropwise condensation, are generally much higher than those achieved during filmwise condensation.

As a larger proportion of the heat transfer surface is exposed during dropwise condensation, heat transfer coefficients may be up to ten times greater than those for filmwise condensation. In the design of heat exchangers where dropwise condensation is promoted, the thermal resistance it produces is often negligible in comparison to other heat transfer barriers. However, maintaining the appropriate conditions for dropwise condensation have proved to be very difficult to achieve.

If the surface is coated with a substance that inhibits wetting, it may be possible to maintain dropwise condensation for a period of time. For this purpose, a range of surface coatings such as Silicones, PTFE and an assortment of waxes and fatty acids are sometimes applied to surfaces in a heat exchanger on which condensation is to be promoted. However, these coatings will gradually lose their effectiveness due to processes such as oxidation or fouling, and film condensation will eventually predominate.

As air is such a good insulator, it provides even more resistance to heat transfer. Air may be between 1500 and 3000 times more resistant to heat flow than steel, and 8000 to 16000 more resistant than copper. This means that a film of air only 0.025 mm thick may resist as much heat transfer as a wall of copper 400 mm thick! Of course all of these comparative relationships depend on the temperature profiles across each layer.

Figure 3.21 illustrates the effect this combination of layers has on the heat transfer process. These barriers to heat transfer not only increase the thickness of the entire conductive layer, but also greatly reduce the mean thermal conductivity of the layer.

The more resistant the layer to heat flow, the larger the temperature gradient is likely to be. This means that to achieve the same desired product temperature, the steam pressure may need to be significantly higher.

The presence of air and water films on the heat transfer surfaces of either process or space heating applications is not unusual. It occurs in all steam heated process units to some degree.

To achieve the desired product output and minimise the cost of process steam operations, a high heating performance may be maintained by reducing the thickness of the films on the condensing surface. In practice, air will usually have the most significant effect on heat transfer efficiency, and its removal from the supply steam will increase heating performance.

## 8. Proper Air Venting

When steam is first admitted to a pipe after a period of shutdown, the pipe is full of air. Further amounts of air and other non-condensable gases will enter with the steam, although the proportions of these gases are normally very small compared with the steam. When the steam condenses, these gases will accumulate in pipes and heat exchangers. Precautions should be taken to discharge them. The consequence of not removing air is a lengthy warming up period, and a reduction in plant efficiency and process performance.

Air in a steam system will also affect the system temperature. Air will exert its own pressure within the system, and will be added to the pressure of the steam to give a total pressure. Therefore, the actual steam pressure and temperature of the steam/air mixture will be lower than that suggested by a pressure gauge.

Of more importance is the effect air has upon heat transfer. A layer of air only 1 mm thick can offer the same resistance to heat as a layer of water 25  $\mu\text{m}$  thick, a layer of iron 2 mm thick or a layer of copper 15 mm thick. It is very important therefore to remove air from any steam system.

Automatic air vents for steam systems (which operate on the same principle as thermostatic steam traps) should be fitted above the condensate level so that only air or steam/air mixtures can reach them. The best location for them is at the end of the steam mains as shown in Figure 3.22. The discharge from an air vent must be piped to a safe place. In practice, a condensate line falling towards a vented receiver can accept the discharge from an air vent.

In addition to air venting at the end of a main, air vents should also be fitted:

- In parallel with an inverted bucket trap or, in some instances, a thermodynamic trap. These traps are sometimes slow to vent air on start-up.

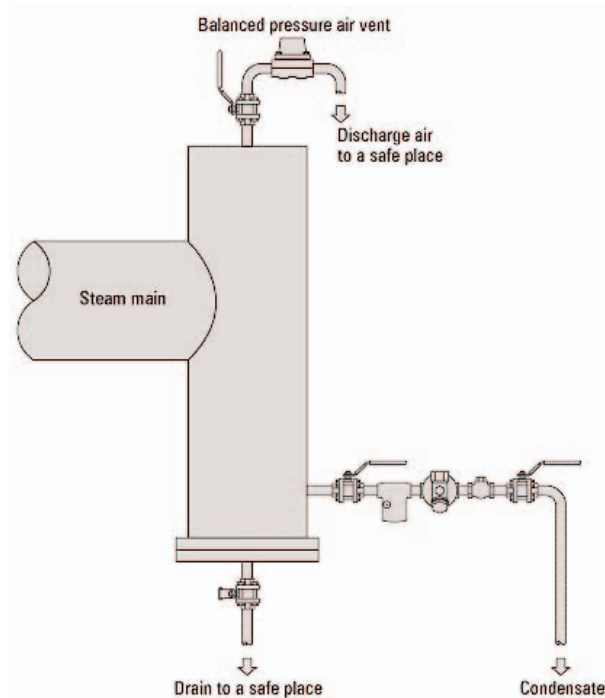
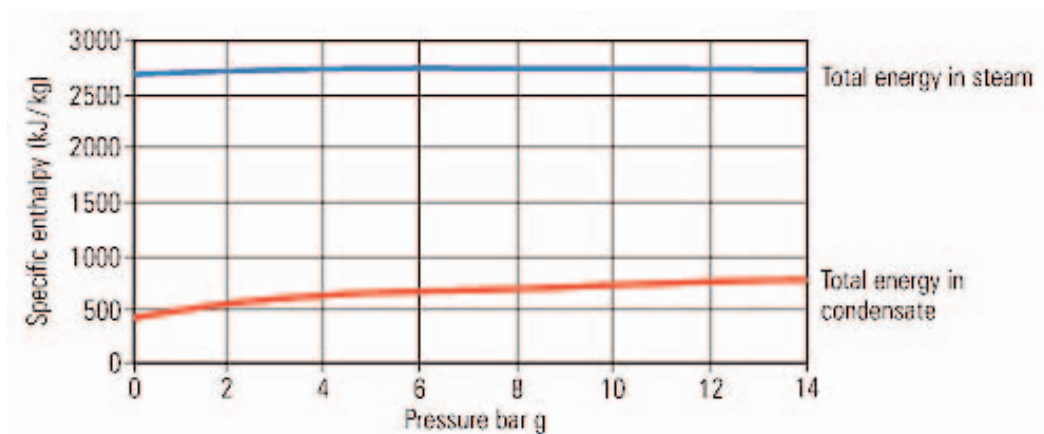

**Figure 3.22 Draining and Venting at the End of a Steam Main**

- In awkward steam spaces (such as at the opposite side to where steam enters a jacketed pan).
- Where there is a large steam space (such as an autoclave), and a steam/air mixture could affect the process quality.

## 9. Condensate Recovery

The steam condenses after giving off its latent heat in the heating coil or the jacket of the process equipment. A sizable portion (about 25%) of the total heat in the steam leaves the process equipment as hot water. Figure 3.23 compares the amount of energy in a kilogram of steam and condensate at the same pressure. The percentage of energy in condensate to that in



**Figure 3.23 Heat Content of Steam and Condensate at the Same Pressure**

steam can vary from 18% at 1 bar g to 30% at 14 bar g; clearly the liquid condensate is worth reclaiming.

If this water is returned to the boiler house, it will reduce the fuel requirements of the boiler. For every 60°C rise in the feed water temperature, there will be approximately 1% saving of fuel in the boiler.

## **Benefits of Condensate Recovery**

### **Financial reasons**

Condensate is a valuable resource and even the recovery of small quantities is often economically justifiable. The discharge from a single steam trap is often worth recovering.

Un-recovered condensate must be replaced in the boiler house by cold make-up water with additional costs of water treatment and fuel to heat the water from a lower temperature.

### **Water charges**

Any condensate not returned needs to be replaced by make-up water, incurring further water charges from the local water supplier.

### **Effluent restrictions**

High temperature of effluent is detrimental to the environment and may damage to pipes. Condensate above this temperature must be cooled before it is discharged, which may incur extra energy costs.

### **Maximising boiler output**

Colder boiler feedwater will reduce the steaming rate of the boiler. The lower the feedwater temperature, the more heat, and thus fuel needed to heat the water.

### **Boiler feedwater quality**

Condensate is distilled water, which contains almost no total dissolved solids (TDS). Boilers need to be blown down to reduce their concentration of dissolved solids in the boiler water. Returning more condensate to the feedtank reduces the need for blowdown and thus reduces the energy lost from the boiler.

Summary of reasons for condensate recovery:

- Water charges are reduced.
- Effluent charges and possible cooling costs are reduced.
- Fuel costs are reduced.
- More steam can be produced from the boiler.
- Boiler blowdown is reduced - less energy is lost from the boiler.
- Chemical treatment of raw make-up water is reduced.

## 10. Insulation of Steam Pipelines and Hot Process Equipments

Heat can be lost due to radiation from steam pipes. As an example while lagging steam pipes, it is common to see leaving flanges uncovered. An uncovered flange is equivalent to leaving 0.6 metre of pipe line unlagged. If a 0.15 m steam pipe diameter has 5 uncovered flanges, there would be a loss of heat equivalent to wasting 5 tons of coal or 3000 litres of oil a year. This is usually done to facilitate checking the condition of flange but at the cost of considerable heat loss. The remedy is to provide easily detachable insulation covers, which can be easily removed when necessary. The various insulating materials used are cork, Glass wool, Rock wool and Asbestos.

The following table 3.3 indicates the heat loss from a hot uninsulated surface to the environment:

<b>TABLE 3.3 QUANTITY OF HEAT LOST AT DIFFERENT TEMPERATURES</b>	
<b>Difference in temperature between ambient &amp; surface</b>	<b>Heat loss</b>
(°C)	(kCal/m <sup>2</sup> /h)
50	500
100	1350
200	3790
400	13640

This is based on 35°C ambient temperature, 0.9 emissivity factor and still wind conditions. The effective insulation of a steam system can bring down the heat losses to less than 75 kCal/m<sup>2</sup>/h

**Note:** Calculation procedure to find out the economic thickness of insulation is given in chapter-5: Insulation and Refractories.

Case Study to elaborate the effect of insulation of flanges: 100 ft of 6 Inch pipe 12 Flanges of 6 Inch = 5 ft of pipe length Heat loss in following 2 cases:

Case (I) - Bare pipe

Case (II) - Pipe with 2 inch insulation aluminum cladding

<b>Parameter</b>	<b>Unit</b>	<b>Case (I)</b>	<b>Case (II)</b>
Heat Loss	kCal/year	36,300	4,100
Steam Loss	kg/Year/100ft	68	3.2
Fuel Loss	kg/Year/100ft	55	0.26
Energy Saving Potential	Rs. Per Year/100 ft	60	2.8

## 11. Flash Steam Recovery

Flash steam is produced when condensate at a high pressure is released to a lower pressure and can be used for low pressure heating.

The higher the steam pressure and lower the flash steam pressure the greater the quantity of flash steam that can be generated. In many cases, flash steam from high pressure equipments is made use of directly on the low pressure equipments to reduce use of steam through pressure reducing valves.

The flash steam quantity can be calculated by the following formula with the help of a steam table:

$$\text{Flash steam available \%} = \frac{S_1 - S_2}{L_2}$$

Where:  $S_1$  is the sensible heat of higher pressure condensate.

$S_2$  is the sensible heat of the steam at lower pressure (at which it has been flashed).

$L_2$  is the latent heat of flash steam (at lower pressure).

**Example:** Calculating the amount of flash steam from condensate

Hot condensate at 7 bar g has a heat content of about 721 kJ/kg. When it is released to atmospheric pressure (0 bar g), each kilogram of water can only retain about 419 kJ of heat. The excess energy in each kilogram of the condensate is therefore  $721 - 419 = 302$  kJ. This excess energy is available to evaporate some of the condensate into steam, the amount evaporated being determined by the proportion of excess heat to the amount of heat required to evaporate water at the lower pressure, which in this example, is the enthalpy of evaporation at atmospheric pressure, 2258 kJ/kg.

$$\text{Therefore, in this example, the percentage of flash steam evaporated} = \frac{302}{2258} \times 100\%$$

$$\text{Flash steam evaporated} = 13.4\%$$

**Example:** Proportion of flash steam using Figure 3.24:

Pressure on the trap = 4 bar g

Flash steam pressure = 0 bar g

% Flash steam = 10%

The amount of flash steam in the pipe is the most important factor when sizing trap discharge lines.

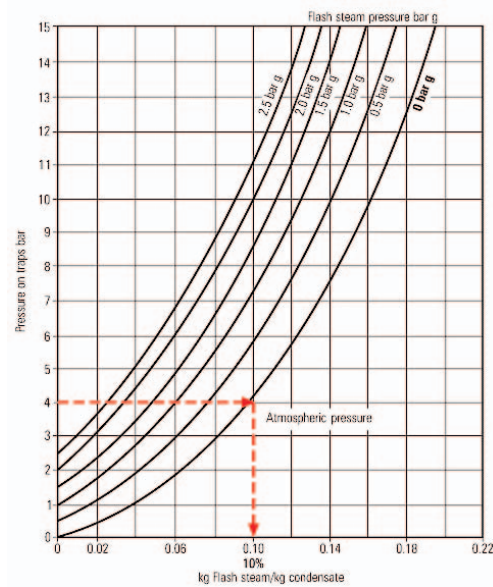
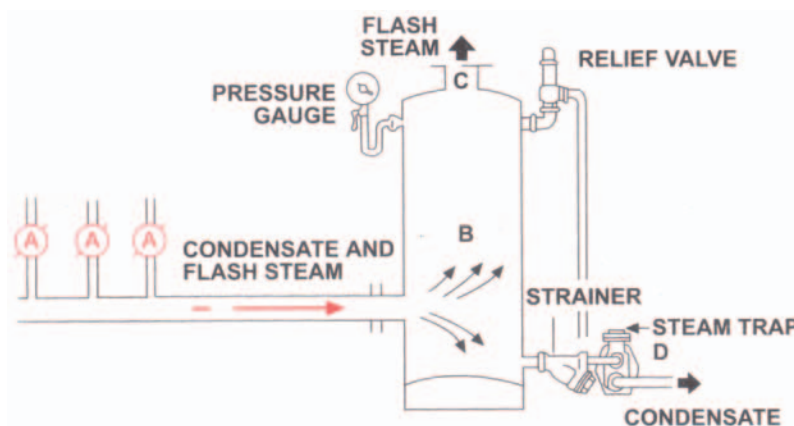

**Figure 3.24 Quantity of Flash Steam Graph**

Flash steam can be used on low pressure applications like direct injection and can replace an equal quantity of live steam that would be otherwise required. The demand for flash steam should exceed its supply, so that there is no build up of pressure in the flash vessel and the consequent loss of steam through the safety valve. Generally, the simplest method of using flash steam is to flash from a machine/equipment at a higher pressure to a machine/equipment at a lower pressure, thereby augmenting steam supply to the low pressure equipment.

In general, a flash system should run at the lowest possible pressure so that the maximum amount of flash is available and the backpressure on the high pressure systems is kept as low as possible.

Flash steam from the condensate can be separated in an equipment called the 'flash vessel'. This is a vertical vessel as shown in the Figure 3.25. The diameter of the vessel is such that a considerable drop in velocity allows the condensate to fall to the bottom of the vessel from where it is drained out by a steam trap preferably a float trap. Flash steam itself rises to leave



**Figure 3.25 Flash Steam Recovery**

the vessel at the top. The height of the vessel should be sufficient enough to avoid water being carried over in the flash steam.

The condensate from the traps (A) along with some flash steam generated passes through vessel (B). The flash steam is let out through (C) and the residual condensate from (B) goes out through the steam trap (D). The flash vessel is usually fitted with a 'pressure gauge' to know the quality of flash steam leaving the vessel. A 'safety valve' is also provided to vent out the steam in case of high pressure build up in the vessel.

## 12. Reducing the Work to be done by Steam

The equipments should be supplied with steam as dry as possible. The plant should be made efficient. For example, if any product is to be dried such as in a laundry, a press could be used to squeeze as much water as possible before being heated up in a dryer using steam.

Therefore, to take care of the above factors, automatic draining is essential and can be achieved by steam traps. The trap must drain condensate, to avoid water hammer, thermal shock and reduction in heat transfer area. The trap should also evacuate air and other non-condensable gases, as they reduce the heat transfer efficiency and also corrode the equipment. Thus, a steam trap is an automatic valve that permits passage of condensate, air and other non-condensable gases from steam mains and steam using equipment, while preventing the loss of steam in the distribution system or equipment.

The energy saving is affected by following measures:

- Reduction in operating hours
- Reduction in steam quantity required per hour
- Use of more efficient technology
- Minimizing wastage.

When the steam reaches the place where its heat is required, it must be ensured that the steam has no more work to do than is absolutely necessary. Air-heater batteries, for example, which provide hot air for drying, will use the same amount of steam whether the plant is fully or partly loaded. So, if the plant is running only at 50 percent load, it is wasting twice as much steam (or twice as much fuel) than necessary.

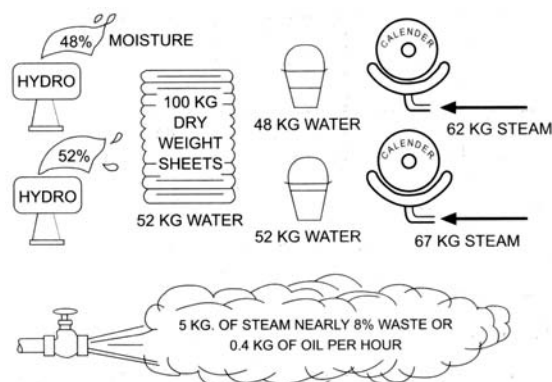

Figure 3.26 Steam Wastage Due to Insufficient Mechanical Drying



Always use the most economical way to removing the bulk of water from the wet material. Steam can then be used to complete the process. For this reason, hydro-extractors, spin dryers, squeeze or calendar rolls, presses, etc. are initially used in many drying processes to remove the mass of water. The efficiency with which this operation is carried out is most important. For example, in a laundry for finishing sheets (100 kg/hr. dry weight), the normal moisture content of the sheets as they leave the hydroextractor, is 48% by weight.

Thus, the steam heated iron has to evaporate nearly 48 kg of water. This requires 62 kg of steam. If, due to inefficient drying in the hydro-extractor, the steam arrive at the iron with 52% moisture content i.e. 52 kg of water has to be evaporated, requiring about 67 kg of steam. So, for the same quantity of finished product, the steam consumption increases by 8 per cent. This is illustrated in Figure 3.26.

<b>QUESTIONS</b>	
1.	Latent heat of steam at lower pressure is lower - True / False?
2.	Name two reasons why steam is used as a heat transfer medium?
3.	The heat which is required to change the phase from water at 100°C to saturated steam is called a) Latent Heat b) Sensible Heat c) Super Heat d) Specific Heat
4.	The slope for steam piping should be a) 12mm in 3 metres b) 12 inches in 3 feet c) 12m in 3 km d) 3m in 12km
5.	The normal velocities encountered in pipes for superheated steam is a) 50–70 m/s b) 30–40 m/s c) 20–25 m/s d) 15–20 m/s
6.	Name two functions of a steam trap?
7.	The major cause for steam trap blowing steam is a) dirt b) too much condensate c) too much steam d) too much air
8.	Ideal trap for steam mains is a) thermodynamic b) float c) inverted bucket d) bimetallic
9.	Name two cases when steam trap can fail?
10.	Name a few methods for testing of steam traps?
11.	How do you distinguish between flash steam and live steam?
12.	The best quality of steam for industrial process heating is a) Dry saturated b) Super heated c) Wet Steam d) High pressure steam
13.	Explain why low-pressure steam is more efficient?
14.	What are the precautions to be taken while steam pressure is reduced for a process?
15.	Discuss the advantages of direct injection versus indirect injection using steam?
16.	List a few barriers to heat transfer in heat exchangers using steam?
17.	1% fuel can be saved in the boiler fuel consumption, if feed water temperature is increased by a) 6°C b) 10°C c) 12°C d) 22°C

18.	Lagging of steam pipes is done to prevent a) Heat loss b) Steam leaks c) High pressures d) Pipe damages
19.	Give an example of: Energy savings by reducing the work done by steam

### REFERENCES

1. Efficient Utilisation of Steam – Energy Efficiency Office, U.K.
2. Efficient Use of Steam – Spirax Sarco
3. Fundamentals of Steam Boilers & Pressure Vessel Inspection Techniques by Homi P. Seervai, Macmillan Company of India Ltd, New Delhi, 1974.
4. Industrial Energy Conservation by *Melvin H. Chiogioji*, Marcel Dekker Inc, 1979, New York.
5. Industrial Heat Generation and Distribution -NIFES Training Manual Issued For CEC - India Energy Bus Project
6. The Efficient Use of Steam by *Oliver Lyle*, Her Majesty Stationery Office, London, 1947.
7. Steam Generation by *J.N. Williams*, George Allen And Unwin Ltd, London, 1969.
8. Improving Steam System Performance a source book for industry by Office of Industrial Technologies, Energy Efficiency and Renewable Energy, US Department of Energy

[www.iclei.org](http://www.iclei.org)

[www.pera.org](http://www.pera.org)

[www.armstrong-intl.com](http://www.armstrong-intl.com)

[www.energy-efficiency.gov.uk](http://www.energy-efficiency.gov.uk)

[www.actionenergy.org.uk](http://www.actionenergy.org.uk)

[www.engineeringtoolbox.com](http://www.engineeringtoolbox.com)